

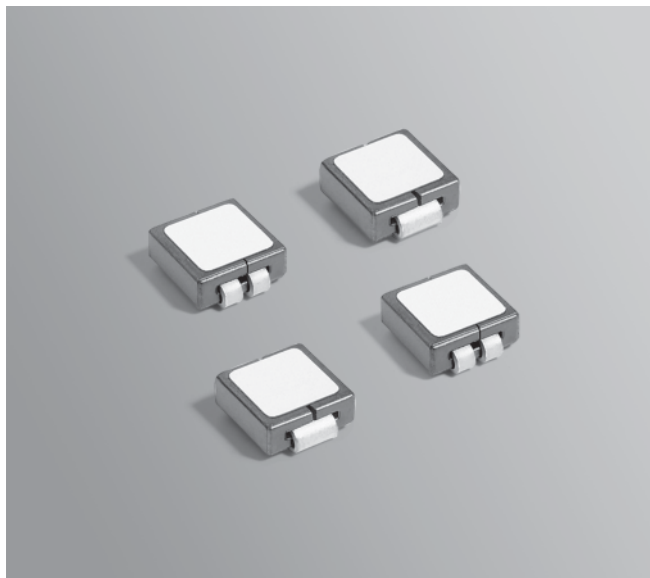

SMT Power Inductors - SLC7530 Series



- Designed for high-speed switch mode applications
- Can be used as a 1:1 transformer or in SEPIC applications

Designer's Kit C379 contains 3 each of all values.

Core material Ferrite

Core and winding loss See www.coilcraft.com/coreloss

Terminations RoHS compliant matte tin over nickel over copper. Other terminations available at additional cost.

Weight: 0.44 – 0.47 g

Ambient temperature –40°C to +85°C with I_{rms} current, +85°C to +125°C with derated current

Storage temperature Component: –40°C to +125°C. Packaging: –55°C to +80°C

Resistance to soldering heat Max three 40 second reflows at +260°C, parts cooled to room temperature between cycles

Moisture Sensitivity Level (MSL) 1 (unlimited floor life at <30°C / 85% relative humidity)

Mean Time Between Failures (MTBF) 26,315,789 hours

Packaging 500/7" reel; 1700/13" reel; Plastic tape: 16 mm wide, 0.33 mm thick, 12 mm pocket spacing, 3.12 mm pocket depth

PCB washing Only pure water or alcohol recommended

Single Conductor

Part number ¹	$L \pm 20\%$ ² (μH)	DCR $\pm 5\%$ ³ (mOhms)	SRF typ ⁴ (GHz)	Isat ⁵ (A)	Irms ⁶ (A)
SLC7530S-500ML_	0.050	0.123	3.80	50	40
SLC7530S-640ML_	0.064	0.123	3.65	32	40
SLC7530S-820ML_	0.082	0.123	3.75	22	40
SLC7530S-101ML_	0.100	0.123	3.75	20	40

Dual Conductor

Leads connected in parallel

Leads connected in series

Part number ¹	$L \pm 20\%$ ² (μH)	DCR $\pm 5\%$ ³ (mOhms)	SRF typ ⁴ (GHz)	Isat ⁵ (A)	Irms ⁶ (A)	$L \pm 20\%$ ² (μH)	DCR max ³ (mOhms)	SRF typ ⁴ (GHz)	Isat ⁵ (A)	Irms ⁶ (A)
SLC7530D-500ML_	0.050	0.209	3.75	50	38	0.188	0.100	1.50	21	17
SLC7530D-640ML_	0.064	0.209	3.65	32	38	0.272	0.100	1.30	14	17
SLC7530D-820ML_	0.082	0.209	3.75	22	38	0.350	0.100	1.20	11	17
SLC7530D-101ML_	0.100	0.209	3.75	20	38	0.400	0.100	0.950	8	17

1. When ordering, please specify **termination** and **packaging** codes:

SLC7530S-101ML C

Termination: L = RoHS compliant matte tin over nickel over copper
Special order: T = RoHS tin-silver-copper (95.5/4/0.5)
 or S = non-RoHS tin-lead (63/37).

Packaging: C = 7" machine-ready reel. EIA-481 embossed plastic tape (500 parts per full reel).

B = Less than full reel. In tape, but not machine ready. To have a leader and trailer added (\$25 charge), use code letter C instead.

D = 13" machine-ready reel. EIA-481 embossed plastic tape. Factory order only, not stocked (1700 parts per full reel).

2. Inductance tested at 100 kHz, 0.1 Vrms using an Agilent/HP 4263B LCR meter or equivalent.

3. DCR is measured on a micro-ohmmeter at points indicated in the diagram.



▲ Points used for measuring DCR

4. SRF measured using an Agilent/HP 8753ES network analyzer and a Coilcraft SMD-D fixture.

5. DC current at which the inductance drops 20% (typ) from its value without current.

6. Current that causes a 40°C rise from 25°C ambient.

7. Electrical specifications at 25°C.

See Qualification Standards section for environmental and test data.

Refer to Doc 362 "Soldering Surface Mount Components" before soldering.

SPICE models

ON OUR WEB SITE OR CD

Coilcraft[®]

Specifications subject to change without notice.
 Please check our website for latest information.

Document 366-1 Revised 09/02/08

1102 Silver Lake Road Cary, Illinois 60013 Phone 847/639-6400 Fax 847/639-1469

E-mail info@coilcraft.com Web <http://www.coilcraft.com>



SMT Power Inductors - SLC7530 Series

Typical L vs Current

Single Conductor

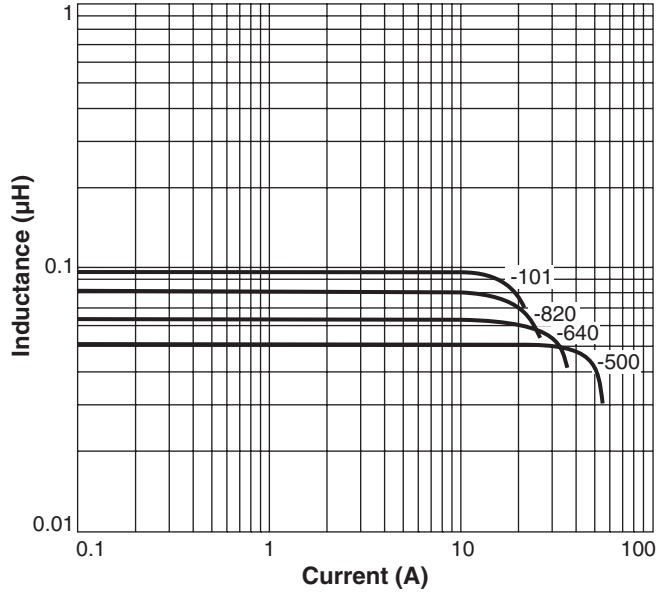

Dual Conductor

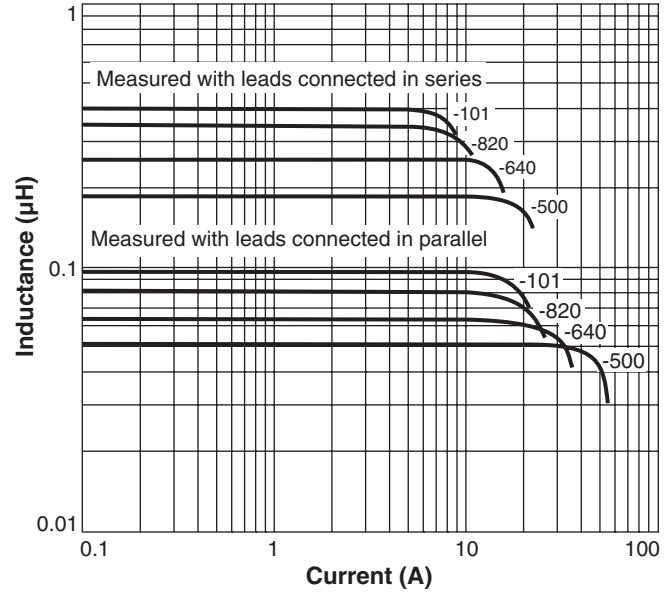

Typical L vs Frequency

Single Conductor

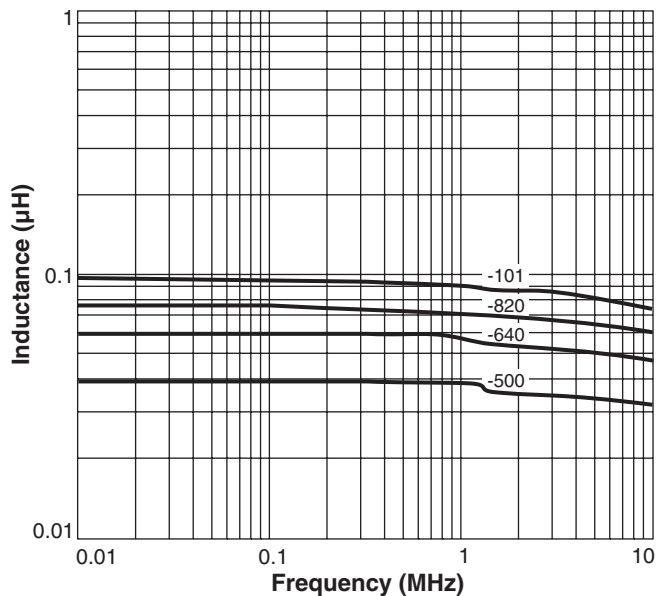

Dual Conductor

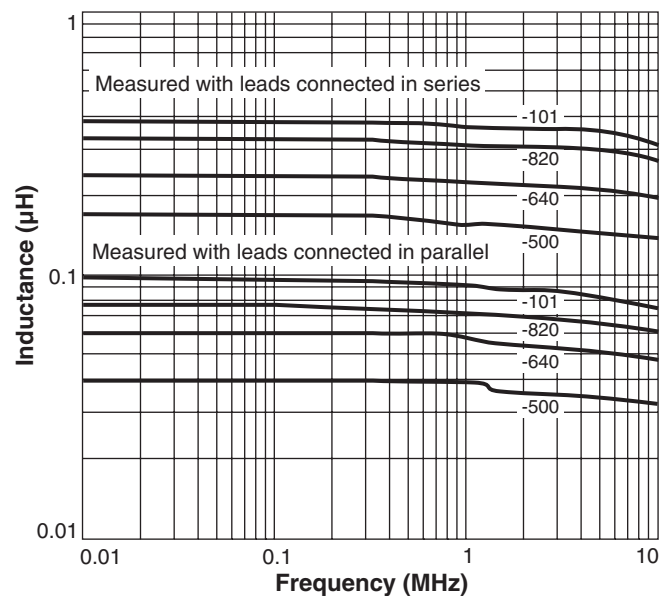

Specifications subject to change without notice.
Please check our website for latest information.

Document 366-2 Revised 09/02/08

1102 Silver Lake Road Cary, Illinois 60013 Phone 847/639-6400 Fax 847/639-1469

E-mail info@coilcraft.com Web <http://www.coilcraft.com>



SMT Power Inductors - SLC7530 Series

Typical Temperature Rise vs Current

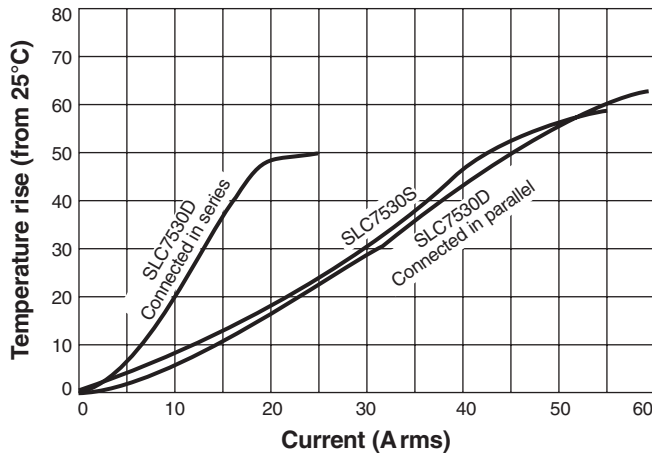

Current Derating

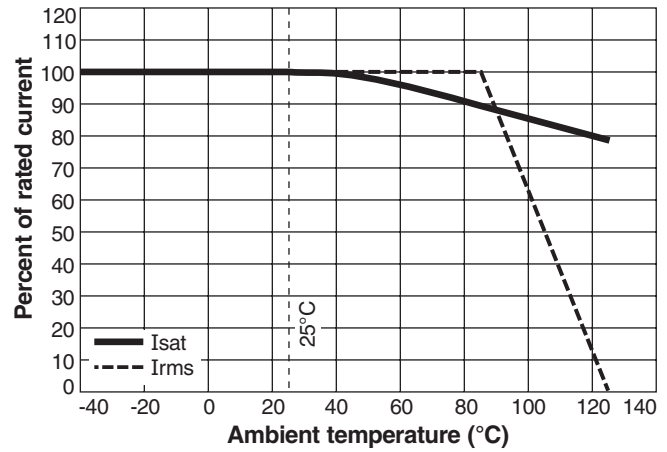

Dimensions – Single Conductor

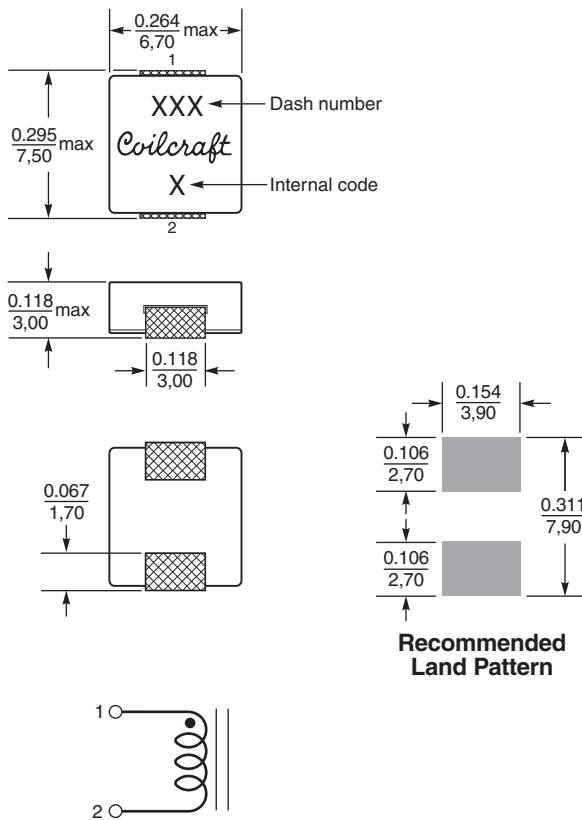

Dimensions are in $\frac{\text{inches}}{\text{mm}}$

Dimensions – Dual Conductor

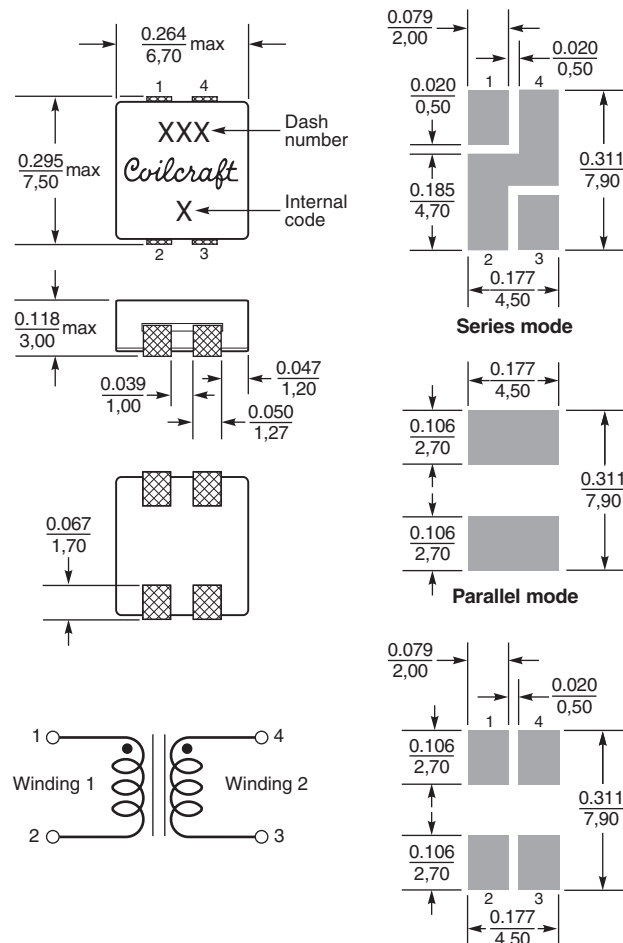

Dimensions are in $\frac{\text{inches}}{\text{mm}}$



Specifications subject to change without notice. Please check our website for latest information.

Document 366-3 Revised 09/02/08

1102 Silver Lake Road Cary, Illinois 60013 Phone 847/639-6400 Fax 847/639-1469

E-mail info@coilcraft.com Web <http://www.coilcraft.com>