



HIGH TEMPERATURE

SMT Power Inductors – MSS1278T



- Designed for high ambient temperatures
- Very low DCR, excellent current handling
- Magnetic shielding for high density mounting

Designer's Kit C419 contains 3 of each value

Core material Ferrite

Terminations RoHS compliant matte tin over nickel over phos bronze. Other terminations available at additional cost.

Weight: 3.8 g – 4.6 g

Ambient temperature –40°C to +125°C with Irms current, +125°C to +165°C with derated current

Storage temperature Component: –40°C to +165°C.
Packaging: –55°C to +80°C

Resistance to soldering heat Max three 40 second reflows at +260°C, parts cooled to room temperature between cycles

Moisture Sensitivity Level (MSL) 1 (unlimited floor life at <30°C / 85% relative humidity)

Mean Time Between Failures (MTBF) 26,315,789 hours

Packaging 500/13" reel; Plastic tape: 24 mm wide, 0.4 mm thick, 16 mm pocket spacing, 8.1 mm pocket depth

PCB washing Only pure water or alcohol recommended

Part number ¹	Inductance ² (µH)	DCR ³ (mOhms)		SRF typ ⁴ (MHz)	Isat (A) ⁵			Irms (A) ⁶	
		typ	max		10% drop	20% drop	30% drop	20°C rise	40°C rise
MSS1278T-102NL_	1.0±30%	6.3	7.0	115	31.84	35.04	36.84	7.1	10.1
MSS1278T-142NL_	1.4±30%	8.8	9.8	85	25.04	27.76	29.52	6.8	9.8
MSS1278T-222NL_	2.2±30%	9.4	10.5	60	22.56	24.80	25.96	6.3	9.2
MSS1278T-272NL_	2.7±30%	10.1	11.3	40	18.76	20.72	22.04	6.1	8.6
MSS1278T-392NL_	3.9±30%	11.7	13.0	35	16.52	18.24	19.20	5.7	7.7
MSS1278T-472ML_	4.7±20%	13.9	15.5	33	15.30	16.90	17.76	4.3	6.2
MSS1278T-562ML_	5.6±20%	15.7	17.5	30	13.38	14.86	15.74	4.3	6.2
MSS1278T-682ML_	6.8±20%	19.1	21.3	23	12.10	13.56	14.20	4.2	6.0
MSS1278T-822ML_	8.2±20%	20.3	22.6	20	11.38	12.60	13.28	4.1	5.9
MSS1278T-103ML_	10±20%	21.8	24.3	17	10.62	11.82	12.48	4.0	5.7
MSS1278T-123ML_	12±20%	23.2	25.8	15	8.90	9.88	10.44	3.7	5.2
MSS1278T-153ML_	15±20%	27.9	31.0	13	8.36	9.32	9.94	3.5	4.9
MSS1278T-183ML_	18±20%	30.8	34.3	12	8.00	8.88	9.36	3.0	4.5
MSS1278T-223ML_	22±20%	35.5	39.5	11	7.08	7.88	8.34	2.9	4.0
MSS1278T-273ML_	27±20%	45.0	50.0	10	6.32	7.08	7.54	2.6	3.6
MSS1278T-333ML_	33±20%	61.9	68.8	9.5	5.96	6.56	6.98	2.3	3.1
MSS1278T-393ML_	39±20%	69.1	76.8	8.5	5.38	5.94	6.28	2.1	3.0
MSS1278T-473ML_	47±20%	72.3	80.4	7.5	4.76	5.40	5.66	2.0	2.9
MSS1278T-563ML_	56±20%	80.2	89.2	7.0	4.40	4.98	5.30	1.9	2.7
MSS1278T-683ML_	68±20%	91.3	101.5	6.5	3.92	4.46	4.74	1.8	2.6
MSS1278T-823ML_	82±20%	125.9	139.9	5.0	3.66	4.08	4.38	1.6	2.3
MSS1278T-104ML_	100±20%	135.1	150.2	4.5	3.12	3.56	3.78	1.5	2.2
MSS1278T-124KL_	120±10%	182.3	202.6	4.3	3.02	3.36	3.58	1.4	1.9
MSS1278T-154KL_	150±10%	216.5	240.6	4.1	2.60	2.94	3.10	1.3	1.8
MSS1278T-184KL_	180±10%	229.0	254.5	4.0	2.36	2.68	2.84	1.2	1.7
MSS1278T-224KL_	220±10%	323.6	359.6	3.4	2.24	2.50	2.62	1.0	1.6
MSS1278T-274KL_	270±10%	415.6	461.8	3.1	1.94	2.18	2.34	0.90	1.2
MSS1278T-334KL_	330±10%	487.3	541.5	2.9	1.72	1.92	2.06	0.80	1.0
MSS1278T-394KL_	390±10%	533.6	592.9	2.7	1.62	1.82	1.92	0.75	1.0
MSS1278T-474KL_	470±10%	707.5	786.2	2.2	1.44	1.64	1.74	0.66	0.90
MSS1278T-564KL_	560±10%	777.4	863.8	2.0	1.40	1.54	1.66	0.60	0.80
MSS1278T-684KL_	680±10%	1045	1162	1.7	1.24	1.32	1.46	0.55	0.75
MSS1278T-824KL_	820±10%	1166	1296	1.4	1.14	1.28	1.42	0.50	0.70
MSS1278T-105KL_	1000±10%	1334	1482	1.3	0.982	1.08	1.18	0.48	0.68

1. Please specify **termination** and **packaging** codes:

MSS1278T-105K L D

Termination: L = RoHS compliant matte tin over nickel over phos bronze.

Special order:

T = RoHS tin-silver-copper (95.5/4/0.5) or S = non-RoHS tin-lead (63/37).

Packaging: D = 13" machine-ready reel. EIA-481 embossed plastic tape (500 parts per full reel).

B = Less than full reel. In tape, but not machine ready.

To have a leader and trailer added (\$25 charge), use code letter D instead.

2. Inductance tested at 100 kHz, 0.1 Vrms, 0 Adc using an Agilent/HP 4263B LCR meter or equivalent.
3. DCR measured on a micro-ohmmeter and a Coilcraft CCF858 test fixture.
4. SRF measured using an Agilent/HP 8753D network analyzer and a Coilcraft SMD-D test fixture.
5. DC current at which the inductance drops the specified amount from its value without current.
6. Current that causes the specified temperature rise from 25°C ambient.
7. Electrical specifications at 25°C.
- See Qualification Standards section for environmental and test data.
- Refer to Doc 362 "Soldering Surface Mount Components" before soldering.

Coilcraft®

Specifications subject to change without notice.
Please check our website for latest information.

Document 598-1 Revised 07/14/08

1102 Silver Lake Road Cary, Illinois 60013 Phone 847/639-6400 Fax 847/639-1469

E-mail info@coilcraft.com Web <http://www.coilcraft.com>



HIGH TEMPERATURE

SMT Power Inductors – MSS1278T Series

Typical L vs Frequency

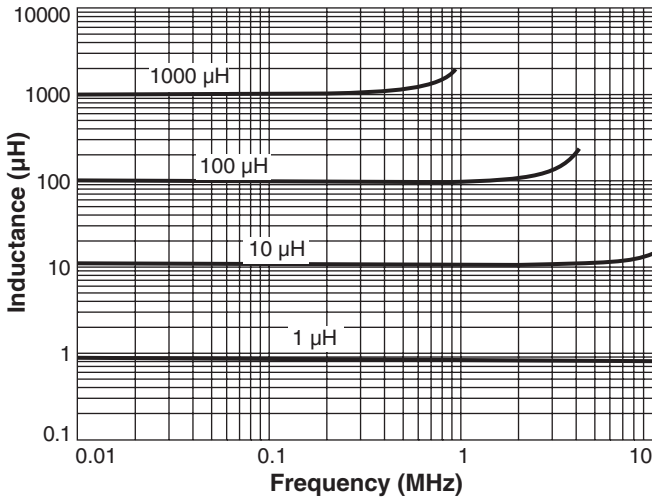

Typical L vs Current

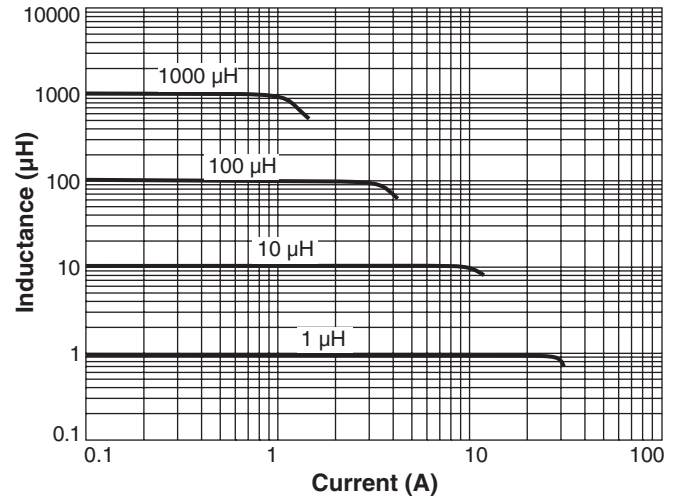

Current Derating

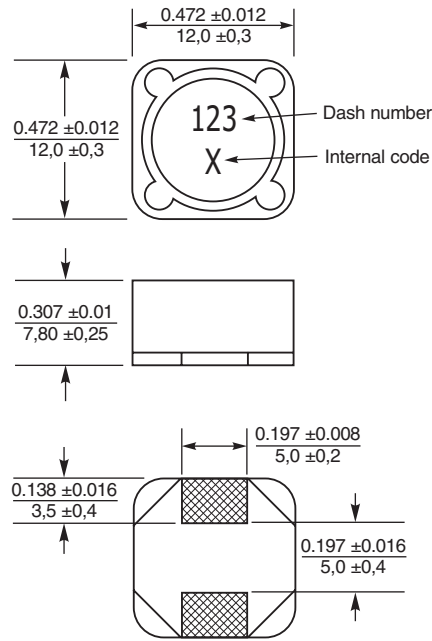
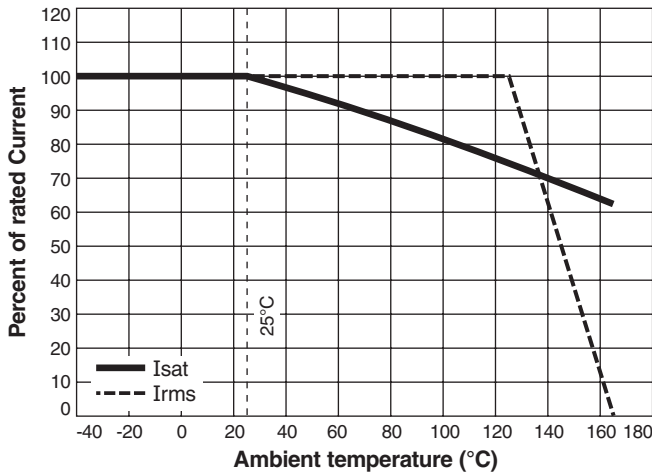

Recommended Land Pattern

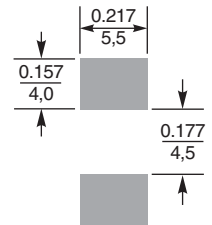

Dimensions are in $\frac{\text{inches}}{\text{mm}}$



Specifications subject to change without notice. Please check our website for latest information.

Document 598-2 Revised 07/14/08

1102 Silver Lake Road Cary, Illinois 60013 Phone 847/639-6400 Fax 847/639-1469

E-mail info@coilcraft.com Web http://www.coilcraft.com