

# Diplex Filters For DOCSIS 1.0, 1.1, 2.0

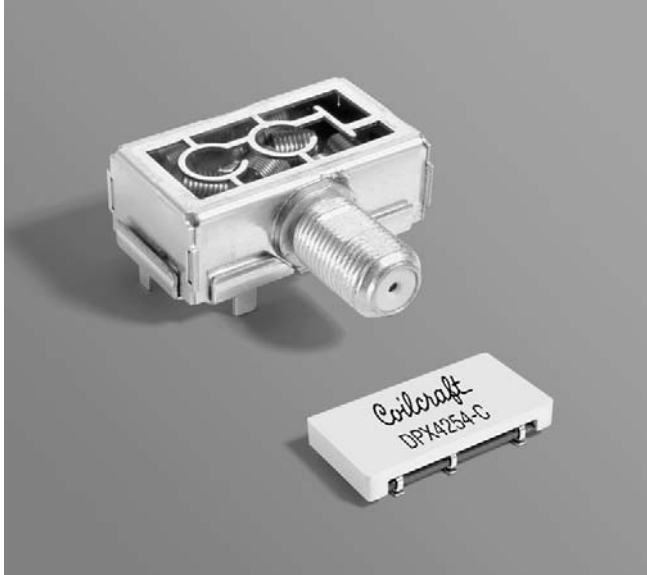

These diplex filter modules provide both low pass and high pass filtering in low cost units that meet the requirements of the DOCSIS 1.0, 1.1 and 2.0 standards. They are intended for two-way broadcast applications like cable modems, set-top boxes and HFC cable network equipment.

The DPX-C parts are low-profile surface mount units that require a minimum of board space. The DPX-B are shielded and come with an integrated coaxial F connector.

In addition to the designs shown here, Coilcraft can custom-engineer diplexers for specific applications. For free evaluation samples, contact Coilcraft or order them on-line at [www.coilcraft.com](http://www.coilcraft.com).

Part number	DOCSIS standard	Low pass filter			High pass filter			I <sub>rms</sub> <sup>1</sup> (mA)
		Passband	Insertion loss	Return loss	Passband	Insertion loss	Return loss	
DPX4254-B	1.0	5 – 42 MHz	≤1.0 dB	≥15 dB	54 – 860 MHz	≤1.5 dB	≥15 dB	500
DPX4254-C	1.0	5 – 42 MHz	≤1.5 dB	≥15 dB	54 – 860 MHz	≤1.5 dB	≥15 dB	150
DPX4288-B	1.1, 2.0	5 – 42 MHz	≤1.5 dB	≥10 dB	88 – 860 MHz	≤1.5 dB	≥10 dB	500
DPX4288-C	1.1, 2.0	5 – 42 MHz	≤1.5 dB	≥10 dB	88 – 860 MHz	≤1.5 dB	≥10 dB	150

1. Average current for a 15°C temperature rise above 25°C ambient.
2. Operating temperature range -40°C to +85°C.
3. Electrical specifications at 25°C.

## Schematic – Shielded Filters (-B)

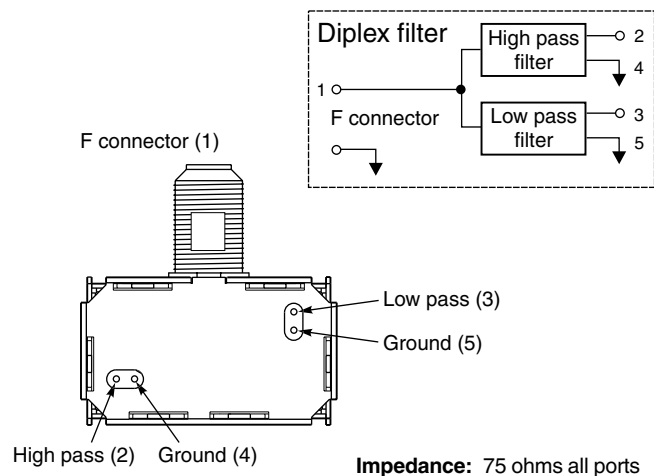

## Schematic – Surface Mount Filters (-C)

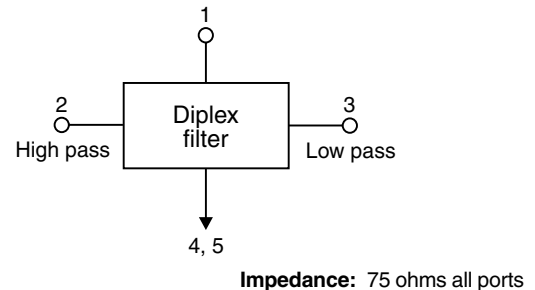

**Coilcraft**<sup>®</sup>

Specifications subject to change without notice.  
Please check our website for latest information.

Document 282-1 Revised 01/11/08

1102 Silver Lake Road Cary, Illinois 60013 Phone 847/639-6400 Fax 847/639-1469

E-mail [info@coilcraft.com](mailto:info@coilcraft.com) Web <http://www.coilcraft.com>

## Shielded Diplex Filter – DPX4254-B

Low pass response

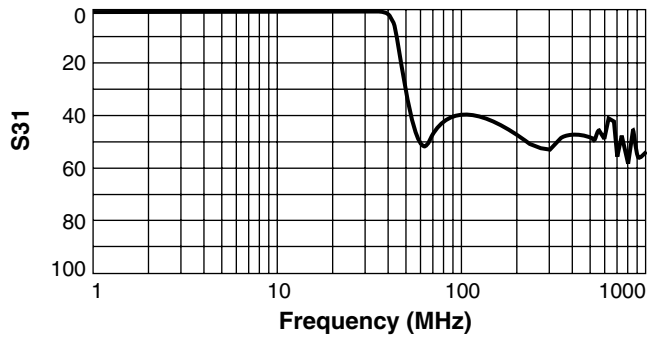

High pass response

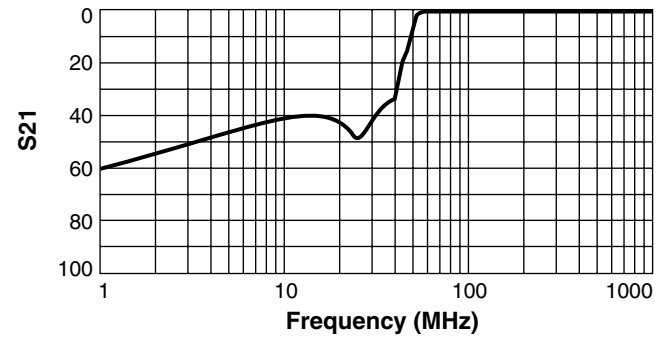

Return loss

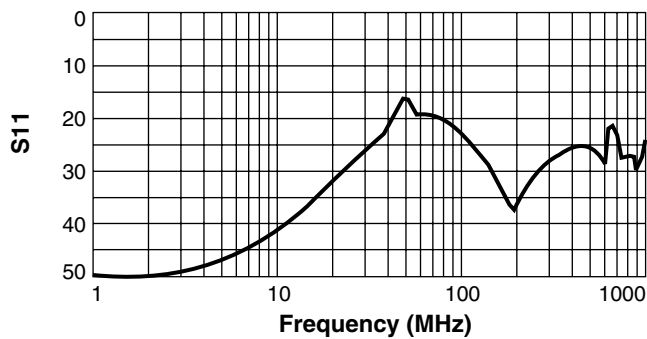

Isolation

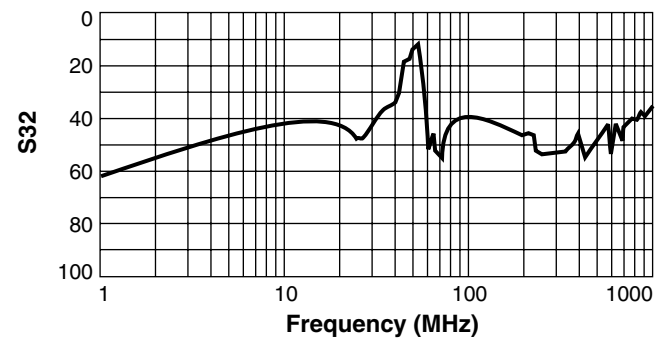

## Unshielded Diplex Filter – DPX4254-C

Low pass response

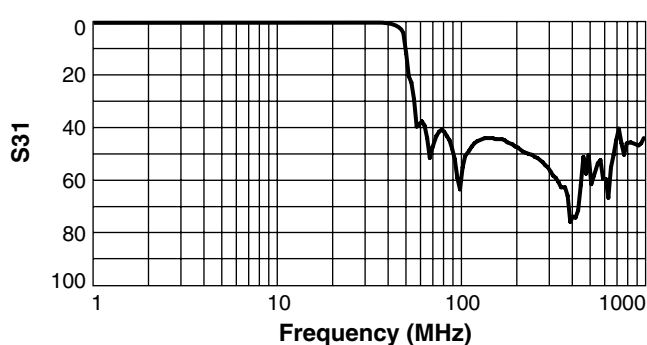

High pass response

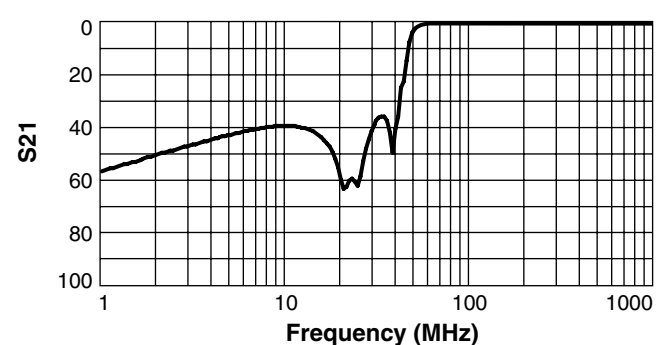

Return loss

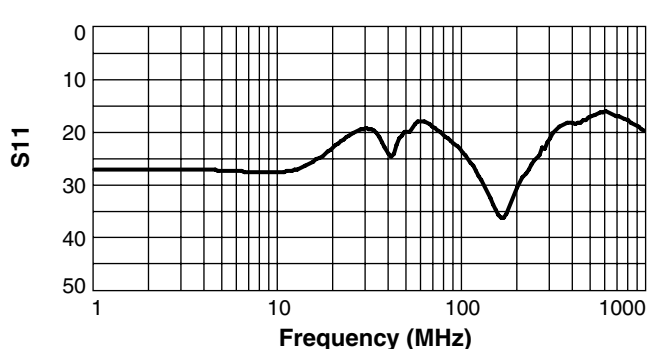

Isolation

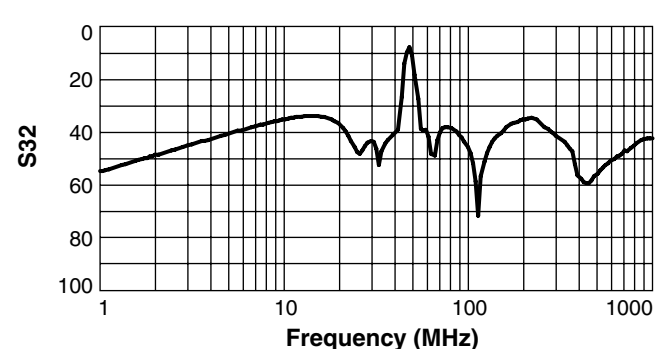

Specifications subject to change without notice.  
Please check our website for latest information.

Document 282-2 Revised 01/11/08

1102 Silver Lake Road Cary, Illinois 60013 Phone 847/639-6400 Fax 847/639-1469

E-mail [info@coilcraft.com](mailto:info@coilcraft.com) Web <http://www.coilcraft.com>

## Shielded Diplex Filter – DPX4288-B

Low pass response

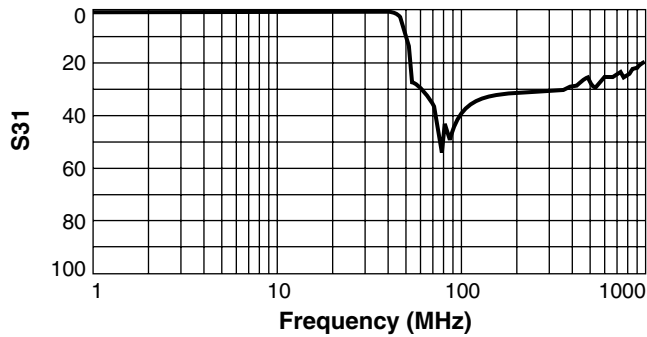

High pass response

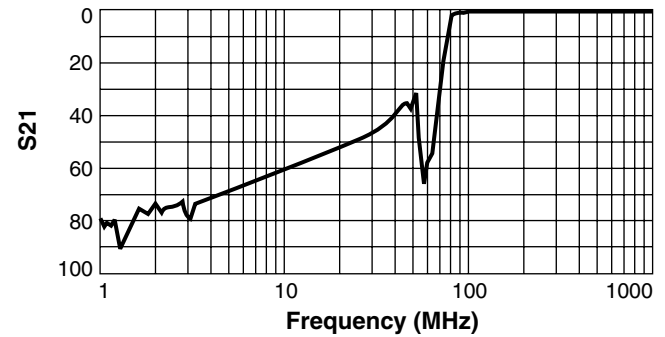

Return loss

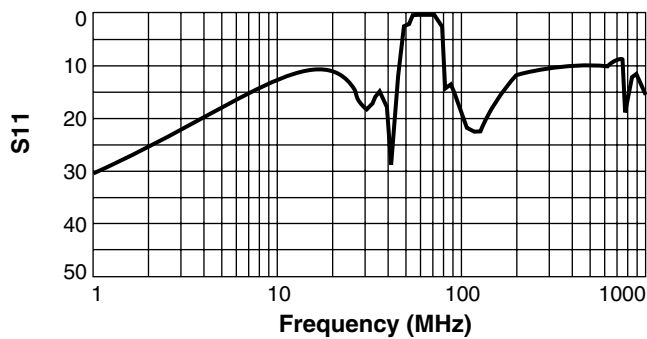

Isolation

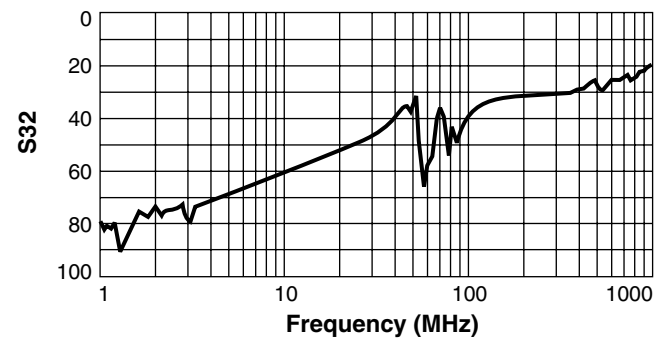

## Unshielded Diplex Filter – DPX4288-C

Low pass response

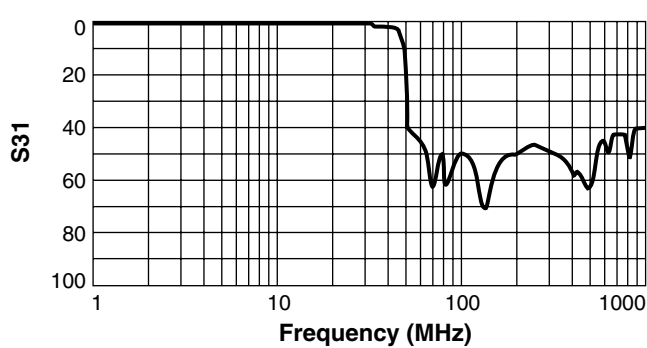

High pass response

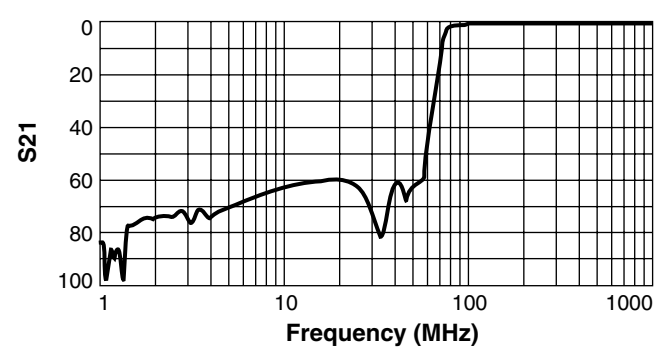

Return loss

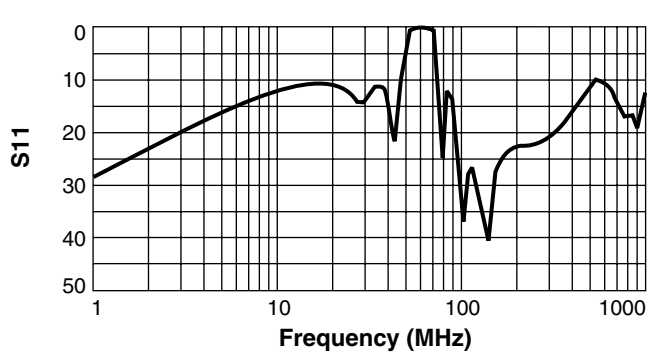

Isolation

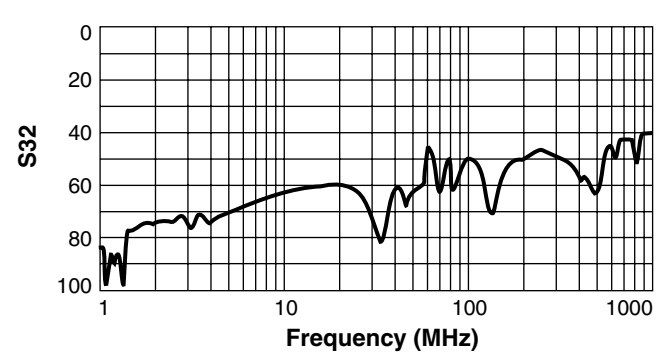

Specifications subject to change without notice. Please check our website for latest information. Document 282-3 Revised 01/11/08

1102 Silver Lake Road Cary, Illinois 60013 Phone 847/639-6400 Fax 847/639-1469

E-mail [info@coilcraft.com](mailto:info@coilcraft.com) Web <http://www.coilcraft.com>

### Dimensions – DPX4254-B, DPX4288-B

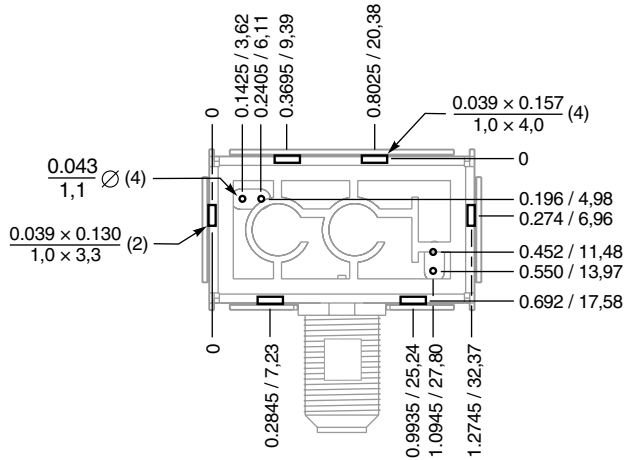
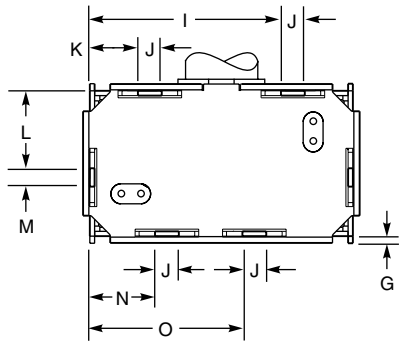
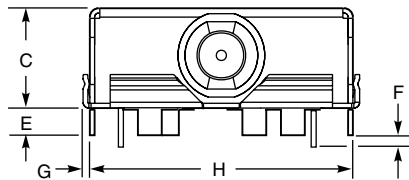
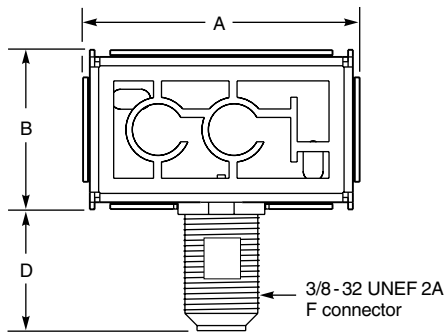

#### Recommended Board Layout

Packaged 25 per tray

A max	B max	C max	D	E	F	G	H
1.40	0.81	0.51	0.580	0.124	0.005	0.035	1.303
35,56	20,57	12,95	14,73	3,15	1,27	0,89	33,10
I	J	K	L	M	N	O	
0.855	0.118	0.229	0.378	0.091	0.311	0.753	
21,72	3,00	5,82	9,60	2,31	7,90	19,13	

### Dimensions – DPX4254-C

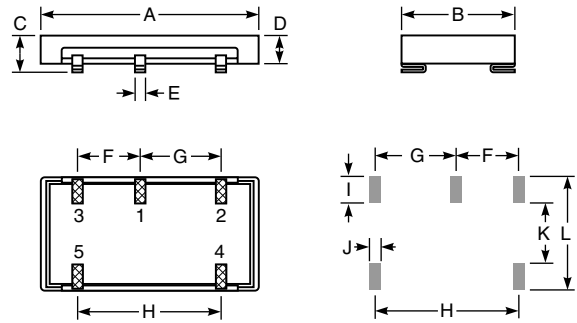

#### Recommended Land Pattern

Packaged 32 per tray

A max	B max	C max	D typ	E	F	G	H	I	J	K	L
1.065	0.560	0.215	0.155	0.050	0.300	0.400	0.700	0.120	0.070	0.305	0.545
17,05	14,22	5,46	3,94	1,27	7,62	10,16	17,78	3,05	1,78	7,75	13,84

### Dimensions – DPX4288-C

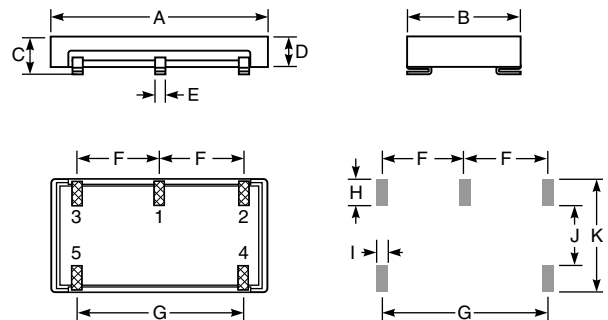

#### Recommended Land Pattern

Packaged 32 per tray

A max	B max	C max	D typ	E	F	G	H	I	J	K
1.065	0.560	0.215	0.155	0.050	0.400	0.800	0.120	0.070	0.305	0.545
17,05	14,22	5,46	3,94	1,27	10,16	20,32	3,05	1,78	7,75	13,84



Specifications subject to change without notice. Please check our website for latest information. Document 282-4 Revised 01/11/08

1102 Silver Lake Road Cary, Illinois 60013 Phone 847/639-6400 Fax 847/639-1469  
 E-mail info@coilcraft.com Web http://www.coilcraft.com